

Datasheet

LL01ZZ-DRXxxL06-Mx

Available Distribution

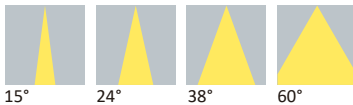

LED

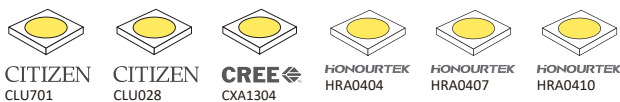

Recommand Applications



General Information

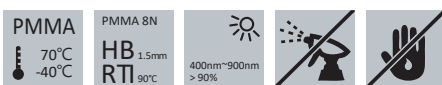

- Lens Material PMMA 8N
 - Operating Temperature -40°C~+70°C
 - UL Flammability HB @ 1.5mm
 - UL RTI Elec 90°C @ 1.5mm
 - Light Transmission Rate 400nm~900nm > 90%
- ☑ If necessary, Clean lenses with mild soap, water and soft cloth.
 ⚠ Never use any commercial cleaning solvents on lenses, like alcohol.
 🧤 Please handle or install lenses with wearing gloves, skin oils may damage lens or its optical characteristic.

Dimensions

Part Number	Diameter	Height
LL01ZZ-DRXxxL06	∅ 44.5	20.5
LL01ZZ-DRXxxL06-Mx	∅ 44.5	23

*All dimensions are in millimeters.

Packaging Details (SPQ)

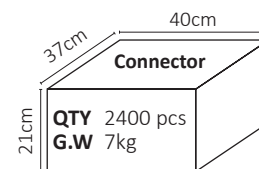
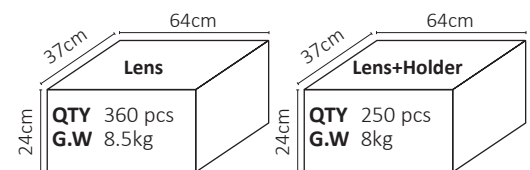

Accessories



- Available with Holder LL01ZZI15Hx
- Available with Connector LL01A00CWJB2, LL01A00CXHB2

Mechanical Specification

*All dimensions are in millimeters.

Lens Dimension

LL01ZZ-DRX×L06

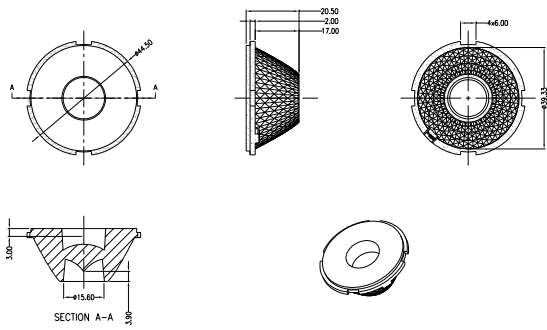

Holder Dimension

LL01ZZZJ15H×

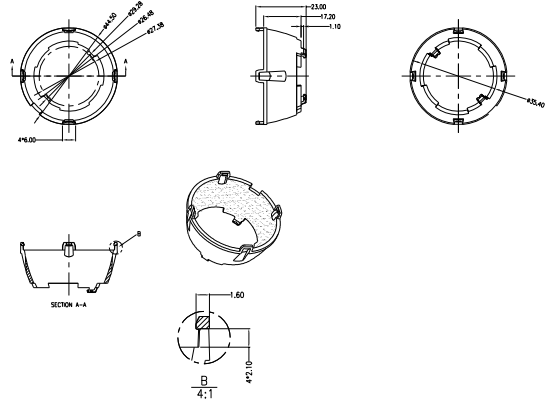

Connector Dimension

LL01A00CWJB2

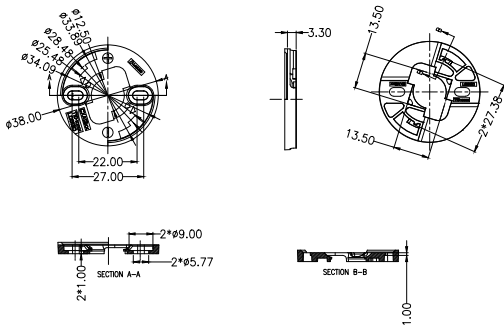

Assembly Instruction

Fixing Method

Part No LL01ZZ-DRX×L06
Holder LL01ZZZJ15H×
Connector LL01A00CWJB2
LED CREE CXA1304 / CITIZEN CLU028

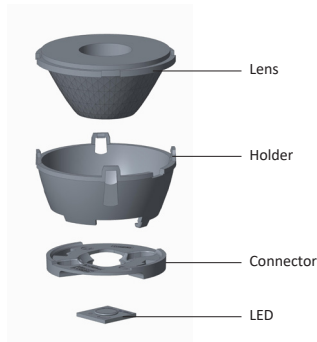

Connector Dimension

LL01A00CXHB2

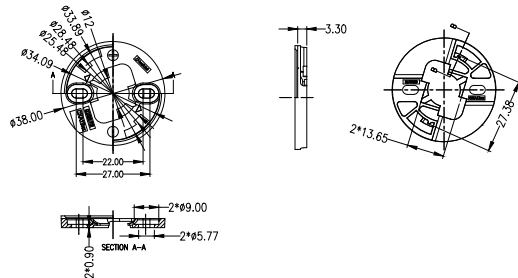

Assembly Instruction

Fixing Method

Part No LL01ZZ-DRX×L06
Holder LL01ZZZJ15H×
Connector LL01A00CXHB2
LED CITIZEN CLU701

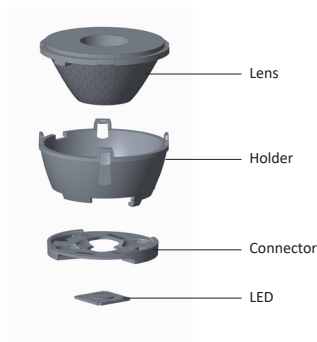

Assembly Instruction

Fixing Method

Part No LL01ZZ-DRX××L06
LED HONOURTEK HRA0404 / HRA0407 / HRA0410



Luminaire
Accessories

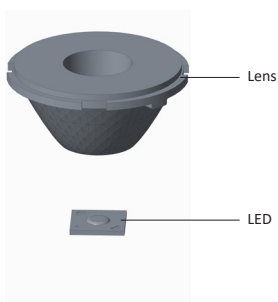

Place the bottom of the lens above
heat-sink with distance 3.5 mm.

Photometric Distribution

LED



15°

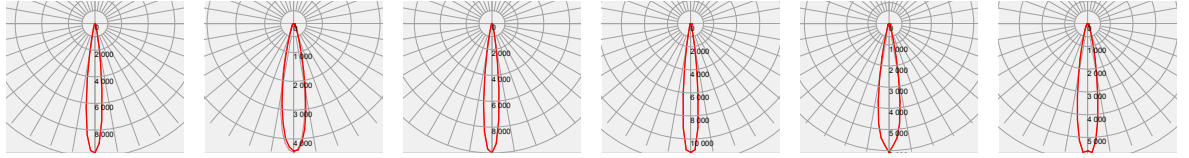

24°

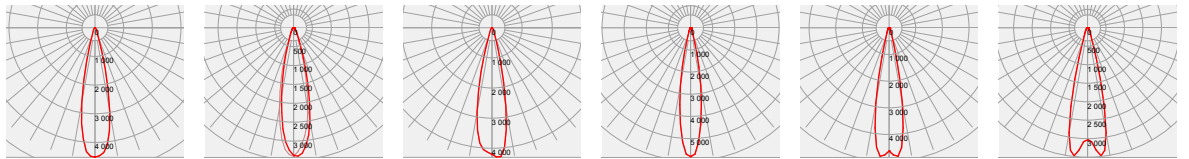



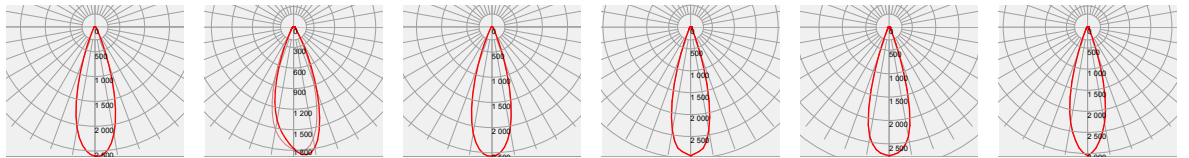



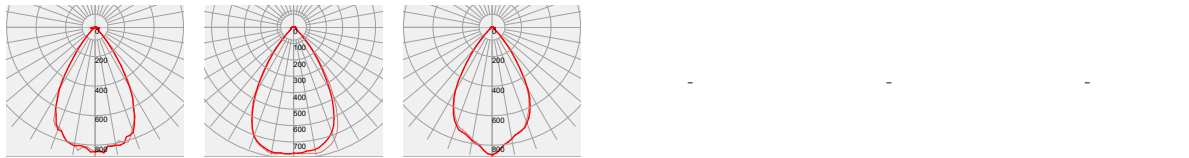

38°





























60°



Details by LED

Part No	Holder	Connector	LED Size	LED
LL01ZZ-DRX××L06	-	-	Ø4.6	   HONOURTEK HRA0404 HONOURTEK HRA0407 HONOURTEK HRA0410
LL01ZZ-DRX××L06-M×	 LL01ZZZJ15H×	 LL01A00CWJB2	Ø6~9.8	  CREE CXA1304 CITIZEN CLU028
		 LL01A00CXHB2	Ø6	 CITIZEN CLU701

LED	Part No	FWHM	cd / lm	IES
 CITIZEN CLU701	LL01ZZ-DRX15L06-M2	13°	9.7	
	LL01ZZ-DRX24L06-M2	22°	4.5	
	LL01ZZ-DRX38L06-M2	32°	2.6	
	LL01ZZ-DRX60L06-M2	62°	0.8	
 CITIZEN CLU028	LL01ZZ-DRX15L06-M2	20°	4.4	
	LL01ZZ-DRX24L06-M2	24°	3.4	
	LL01ZZ-DRX38L06-M2	37°	1.8	
	LL01ZZ-DRX60L06-M2	64°	0.7	
 CREE CXA1304	LL01ZZ-DRX15L06-M2	13°	9.9	
	LL01ZZ-DRX24L06-M2	23°	4.2	
	LL01ZZ-DRX38L06-M2	32°	2.5	
	LL01ZZ-DRX60L06-M2	63°	0.8	

LED	Part No	FWHM	cd / lm	IES
 HONOURTEK HRA0404	LL01ZZ-DRX15L06	12°	11.1	
	LL01ZZ-DRX24L06	18°	5.8	
	LL01ZZ-DRX38L06	30°	2.9	
	LL01ZZ-DRX60L06-M2	-	-	-
 HONOURTEK HRA0407	LL01ZZ-DRX15L06	18°	6.0	
	LL01ZZ-DRX24L06	21°	4.8	
	LL01ZZ-DRX38L06	32°	2.7	
	LL01ZZ-DRX60L06-M2	-	-	-
 HONOURTEK HRA0410	LL01ZZ-DRX15L06	17°	5.6	
	LL01ZZ-DRX24L06	26°	3.4	
	LL01ZZ-DRX38L06	30°	3.0	
	LL01ZZ-DRX60L06-M2	-	-	-

Product Nomenclature

Ledlink Led Type Lens Angle Holder
LL 01 ZZ -DRX 15 L06 -M2
Lens Dot Number Serial Number Type of Material

Ledlink Optics, Inc Taiwan HQ

15F, No.655, Bannan Rd., Chung-Ho Dist.,
New Taipei City, Taiwan 235

Ledlink Optics (Dongguan) Co., Ltd Dongguan Factory

No.5, TianKeng Industrial Dist., HengLiTown, DongGuan City,
GuangDong Province, China 523478

Ledlink Optics (Yangzhou) Co., Ltd Yangzhou Factory

No.180, LinJiang Rd., YangZhou City, Jiangsu Province, China 225009

www.ledlink-optics.com

service@ledlink-optics.com

